



# LCD MODULE SPECIFICATION

**Customer:** \_\_\_\_\_  
**Model Name:** HC043TE50029 -B03V02  
**Date:** 2019/02/25  
**Version:** 01

**Preliminary Specification**  
**Final Specification**

**For Customer's Acceptance**

Approved by	Comment

Approved by	Reviewed by	Prepared by

## Record of Revision

Version	Revise Date	Page	Content
Pre-spec .01	2019/02/25		Initial Release.

# Contents

1. General Specifications .....	1
2. Pin Assignment .....	2
2.1. TFT LCD Panel Driving Section.....	2
2.2. Touch Screen Panel Section.....	4
3. Operation Specifications.....	5
3.1. Absolute Maximum Ratings .....	5
3.2. Typical operation conditions .....	6
3.3 Backlight Driving Conditions .....	6
3.4. Power Sequence .....	7
3.5. Timing Characteristics .....	8
3.5.1. Timing Conditions .....	8
3.5.2. Timing Diagram .....	9
4. Touch Screen Panel Specifications .....	10
4.1. Electrical Characteristics .....	10
4.2. Mechanical & Reliability Characteristics .....	11
4.3. Linearity Definition .....	12
4.4. Housing design guide .....	13
5. Optical Specifications .....	14
6. Reliability Test Items .....	18
7. General Precautions .....	19
7.1. Safety .....	19
7.2. Handling .....	19
7.3. Static Electricity.....	19
7.4. Storage .....	19
7.5. Cleaning .....	19
8. Mechanical Drawing .....	20
9. Package Drawing .....	21
9.1. Packaging Material Table.....	21
9.2. Packaging Quantity.....	21
9.3. Packaging Drawing.....	22

# 1. General Specifications

No.	Item	Specification	Remark
1	LCD size	4.3 inch(Diagonal)	
2	Driver element	a-Si TFT active matrix	
3	Resolution	480 × 3 (RGB) × 272	
4	Display mode	Normally White, Transmissive	
5	Dot pitch	0.066(W) × 0.198(H) mm	
6	Active area	95.04(W) × 53.856(H) mm	
7	Module size	105.5(W) × 67.2(H) × 2.9(D) mm	Note 1
8	Surface treatment	Anti-Glare	
9	Color arrangement	RGB-stripe	
10	Interface	Digital	
11	Backlight Power consumption	0.558 W(Typ.)	
12	Panel Power consumption	0.056 W (Typ.)	
13	Weight	TBD	

Note 1: Refer to Mechanical Drawing.

## 2. Pin Assignment

### 2.1.TFT LCD Panel Driving Section

FPC Connector is used for the module electronics interface. The recommended model is "FH19SC-40S-0.5SH" manufactured by HIROSE.

Pin No.	Symbol	I/O	Function	Remark
1	V <sub>LED-</sub>	P	Power for LED backlight cathode	
2	V <sub>LED+</sub>	P	Power for LED backlight anode	
3	GND	P	Power ground	
4	V <sub>DD</sub>	P	Power voltage	
5	R0	I	Red data (LSB)	
6	R1	I	Red data	
7	R2	I	Red data	
8	R3	I	Red data	
9	R4	I	Red data	
10	R5	I	Red data	
11	R6	I	Red data	
12	R7	I	Red data (MSB)	
13	G0	I	Green data (LSB)	
14	G1	I	Green data	
15	G2	I	Green data	
16	G3	I	Green data	
17	G4	I	Green data	
18	G5	I	Green data	
19	G6	I	Green data	
20	G7	I	Green data (MSB)	

21	B0	I	Blue data (LSB)	
22	B1	I	Blue data	
23	B2	I	Blue data	
24	B3	I	Blue data	
25	B4	I	Blue data	
26	B5	I	Blue data	
27	B6	I	Blue data	
28	B7	I	Blue data (MSB)	
29	GND	P	Power ground	
30	CLK	I	Pixel clock	
31	DISP	I	Display on/off	
32	HS			
33	VS			
34	DE	I	Data Enable	
35	NC	-	No connection	
36	GND	P	Power ground	
37	NC			
38	NC			
39	NC			
40	NC			

I: input, O: output, P: Power

### 3. Operation Specifications

#### 3.1. Absolute Maximum Ratings

(Note 1)

Item	Symbol	Values		Unit	Remark
		Min.	Max.		
Power voltage	V <sub>DD</sub>	-0.5	5.0	V	
Input signal voltage	Logic input	-0.5	5.0	V	
Operation temperature	T <sub>OP</sub>	-20	70	°C	Note 3, 4
Storage temperature	T <sub>ST</sub>	-20	70	°C	Note 3, 4
LED Reverse Voltage	V <sub>R</sub>	-	1.2	V	Each LED Note 2
LED Forward Current	I <sub>F</sub>	-	25	mA	Each LED

Note 1: The absolute maximum rating values of this product are not allowed to be exceeded at any times. A module should be used with any of the absolute maximum ratings exceeded, the characteristics of the module may not be recovered, or in an extreme condition, the module may be permanently destroyed.

Note 2: V<sub>R</sub> Conditions: Zener Diode 20mA

Note 3: 90% RH Max. (Max wet temp. is 60°C)

Maximum wet-bulb temperature is at 60°C or less. And No condensation (no drops of dew)

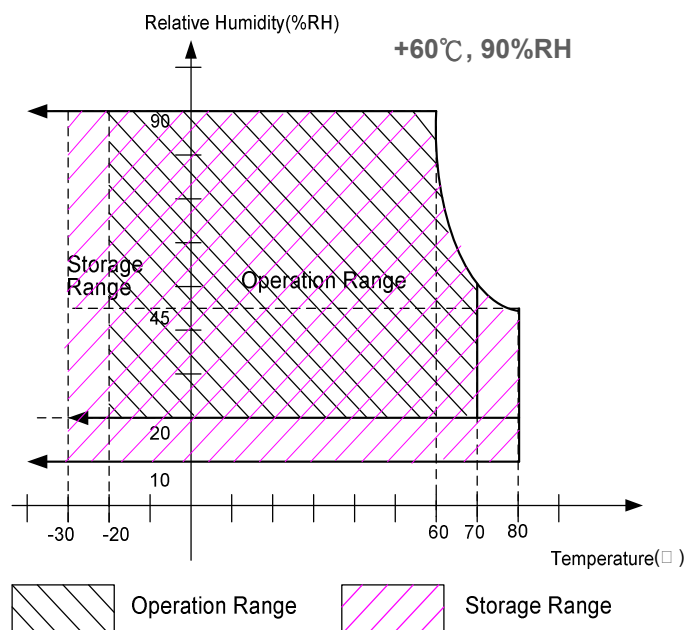

Note 4: In case of temperature below 0°C, the response time of liquid crystal (LC) becomes slower and the color of panel darker than normal one.

### 3.2. Typical operation conditions

Item	Symbol	Values			Unit	Remark
		Min.	Typ.	Max.		
Power voltage	$V_{DD}$	3.1	3.3	3.5	V	
Current for Driver	$I_{V_{DD}}$	-	17	25	mA	$V_{DD} = 3.3V$
Input logic high voltage	$V_{IH}$	$0.8V_{DD}$	-	$V_{DD}$	V	Note 1
Input logic low voltage	$V_{IL}$	GND	-	$0.2V_{DD}$	V	

Note1: CLK, DE, R0~ R7, G0~ G7, B0~ B7.

### 3.3 Backlight Driving Conditions

Item	Symbol	Values			Unit	Remark
		Min.	Typ.	Max.		
Voltage for LED Backlight	$V_L$	-	15.5	-	V	Note 2
Current for LED Backlight	$I_L$	-	40	-	mA	
LED life time	-	30,000	-	-	Hr	Note 1

Note 1: The “LED life time” is defined as the module brightness decrease to 50% original brightness that the ambient temperature is 25°C and  $I_L = 40mA$ . The LED lifetime could be decreased if operating  $I_L$  is larger than 40 mA.

Note 2: The LED Supply Voltage is defined by the number of LED at  $T_a = 25^\circ C$  and  $I_L = 40mA$ .



### 3.4. Power Sequence

To prevent a latch-up or DC operation of the LCD module, the power on/off sequence should be as the diagram below.

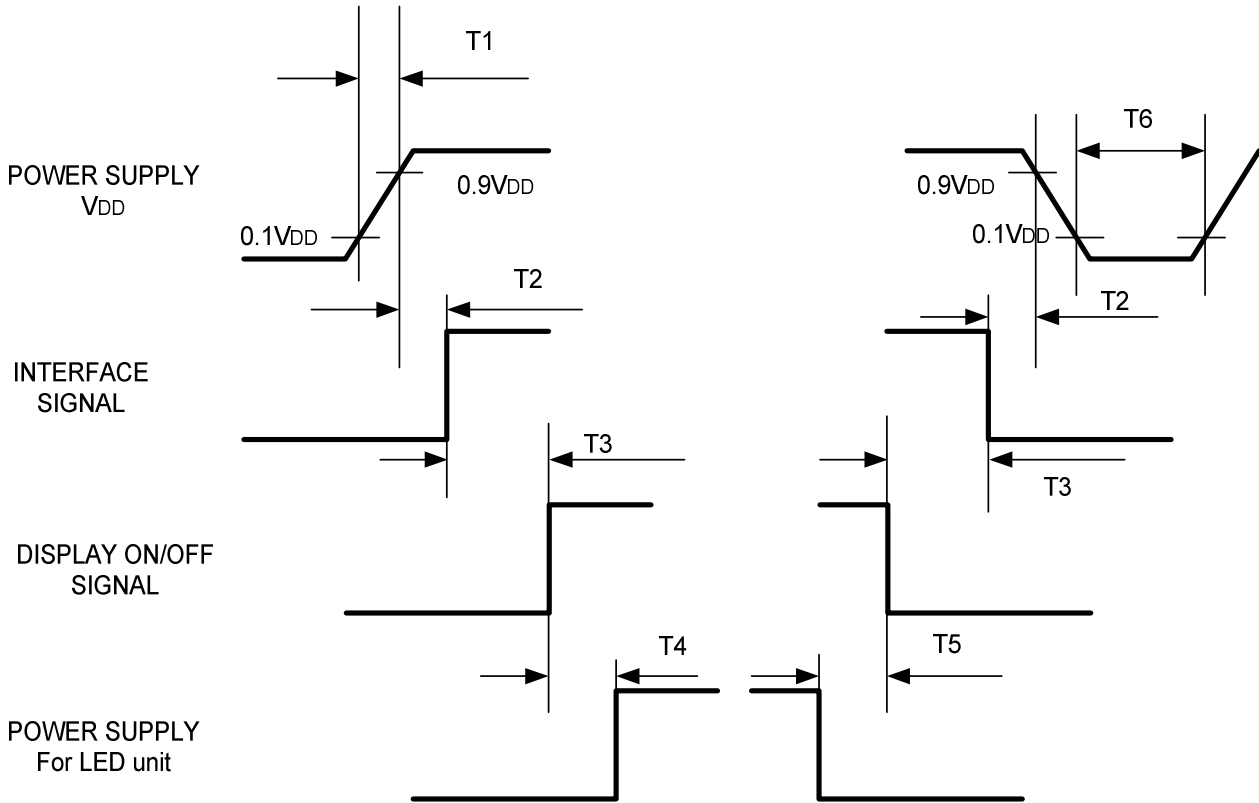

Symbol	Specification	Symbol	Specification
T1	$0 \leq T1 \leq 10 \text{ msec}$	T4	$160 \text{ msec} \leq T4$
T2	$0 \leq T2 \leq 100 \text{ msec}$	T5	$160 \text{ msec} \leq T5$
T3	$0 \leq T3 \leq 200 \text{ msec}$	T6	$1 \text{ msec} \leq T6$

## 3.5. Timing Characteristics

### 3.5.1. Timing Conditions

Parallel DE mode RGB input timing table

Parameter	Symbol	Value			Unit
		Min.	Typ.	Max.	
CLK frequency	fclk	7	9	12	MHz
DEV period time	Tv	277	288	400	H
DEV display area	Tvd	272			H
DEV blanking	Tvb	5	16	128	H
DEH period time	Th	520	525	800	CLK
DEH display area	Thd	480			CLK
DEH blanking	Thb	40	45	320	CLK
CLK cycle time	Tclk	83	110	143	ns
Clock width of high level	Tcwh	40	50	60	%
Clock width of low level	Tcwl	40	50	60	%
Clock rising time	t <sub>rck</sub>		-	9	ns
Clock falling time	t <sub>fcck</sub>		-	9	ns
Data Setup Time	t <sub>desu</sub>	10	-	-	ns
Data Hold Time	t <sub>dahd</sub>	10	-	-	ns
DE Setup Time	t <sub>desu</sub>	10	-	-	ns
DE Hold Time	t <sub>dehd</sub>	10	-	-	ns

### 3.5.2. Timing Diagram

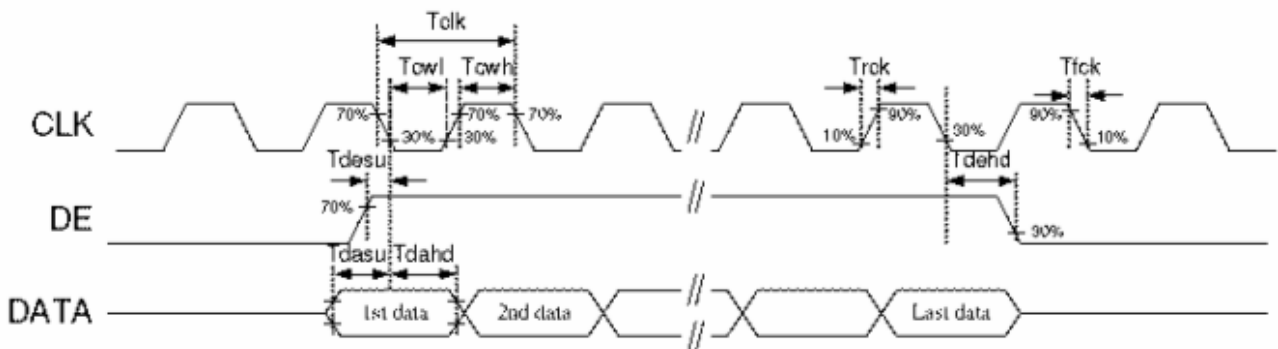
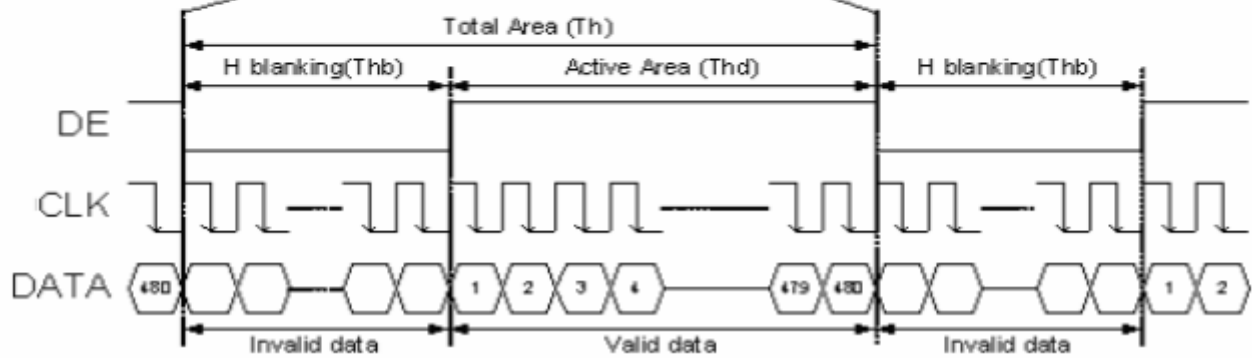
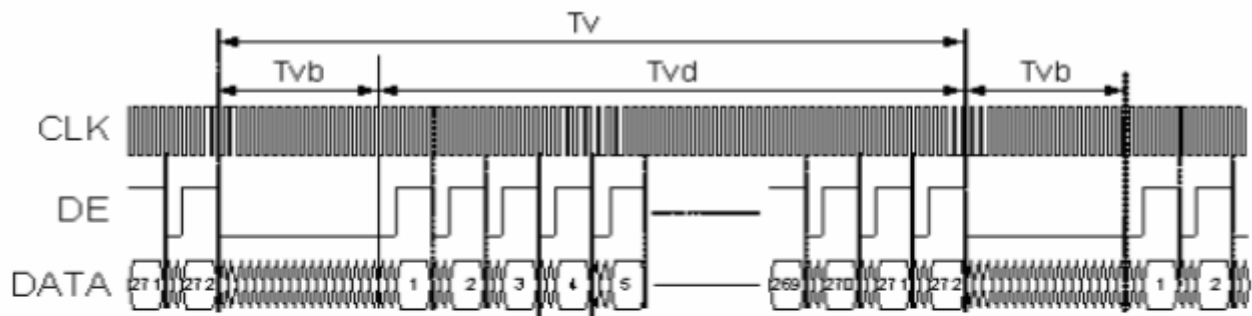

## 5. Optical Specifications

Item	Symbol	Condition	Values			Unit	Remark
			Min.	Typ.	Max.		
Viewing angle (CR≥ 10)	$\theta_L$	$\Phi=180^\circ$ (9 o'clock)	60	70	-	degree	Note 1 Note 7
	$\theta_R$	$\Phi=0^\circ$ (3 o'clock)	60	70	-		
	$\theta_T$	$\Phi=90^\circ$ (12 o'clock)	40	50	-		
	$\theta_B$	$\Phi=270^\circ$ (6 o'clock)	60	70	-		
Response time	$T_{ON}$	Normal $\theta=\Phi=0^\circ$	-	10	20	msec	Note 3
	$T_{OFF}$		-	15	30	msec	Note 3
Contrast ratio	CR		400	500	-	-	Note 4
Color chromaticity	$W_X$		-	-	-	-	Note 2 Note 5 Note 6 Note 7
	$W_Y$		-	-	-	-	
Luminance			-	500	-	cd/m <sup>2</sup>	Note 6
Luminance uniformity	$Y_U$		70	75	-	%	Note 8

Test Conditions:

1.  $V_{DD}=3.3V$ ,  $I_L=40mA$  (Backlight current), the ambient temperature is  $25^\circ C$ .
2. The test systems refer to Note 2.

Note 1: Definition of viewing angle range

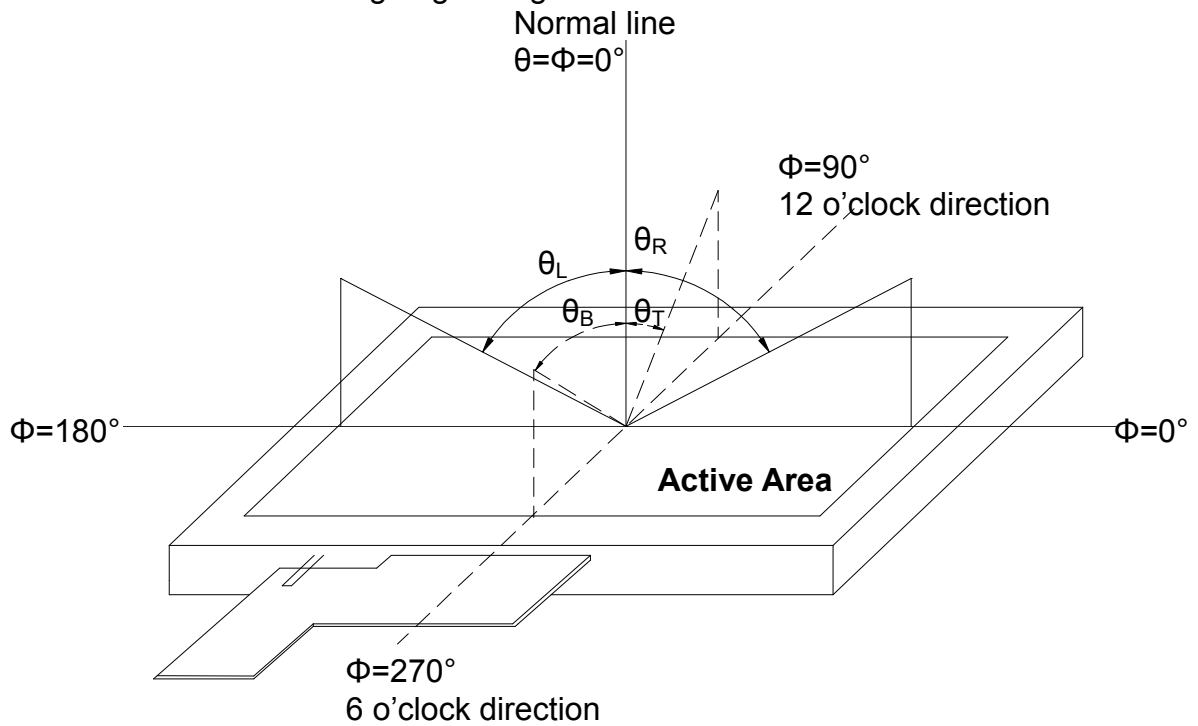

Fig. 4-1 Definition of viewing angle

Note 2: Definition of optical measurement system.

The optical characteristics should be measured in dark room. After 30 minutes operation, the optical properties are measured at the center point of the LCD screen. (Response time is measured by Photo detector TOPCON BM-7, other items are measured by BM-5A/Field of view:  $1^\circ$  /Height: 500mm.)

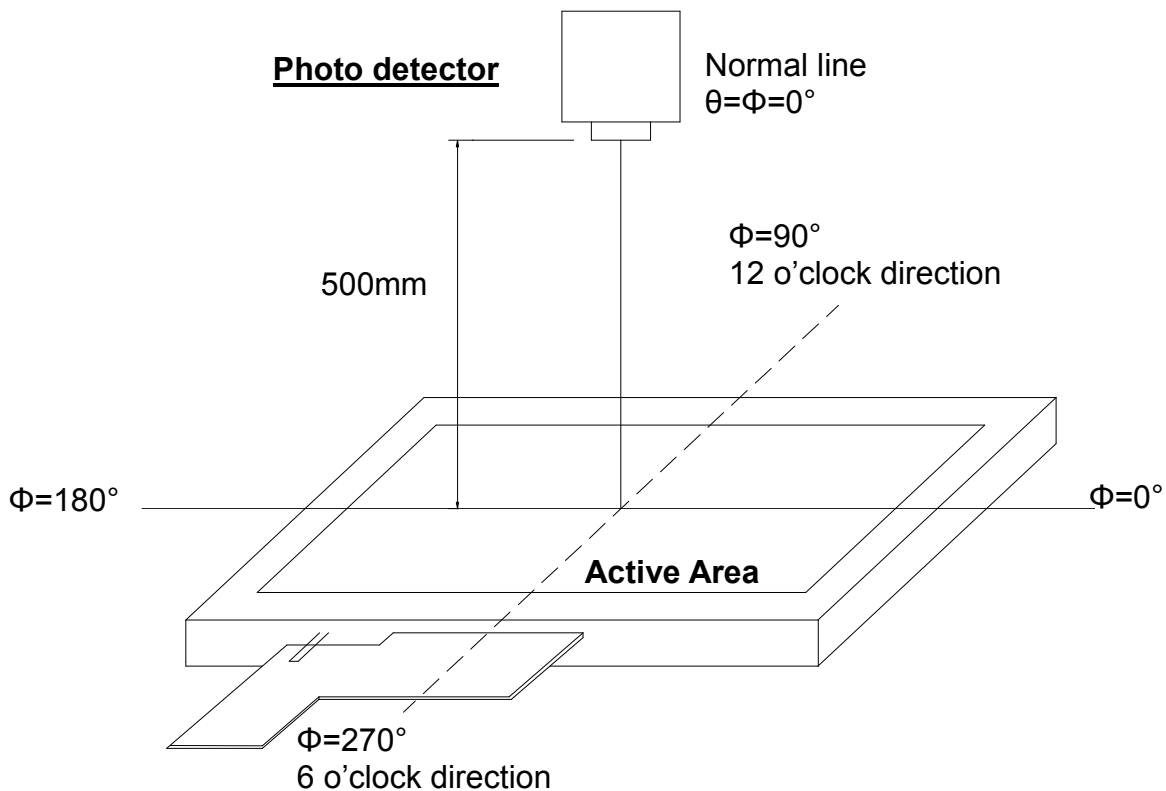

Fig. 4-2 Optical measurement system setup

The copyright belongs to InnoLux. Any unauthorized use is prohibited.

Note 3: Definition of Response time

The response time is defined as the LCD optical switching time interval between "White" state and "Black" state. Rise time ( $T_{ON}$ ) is the time between photo detector output intensity changed from 90% to 10%. And fall time ( $T_{OFF}$ ) is the time between photo detector output intensity changed from 10% to 90%.

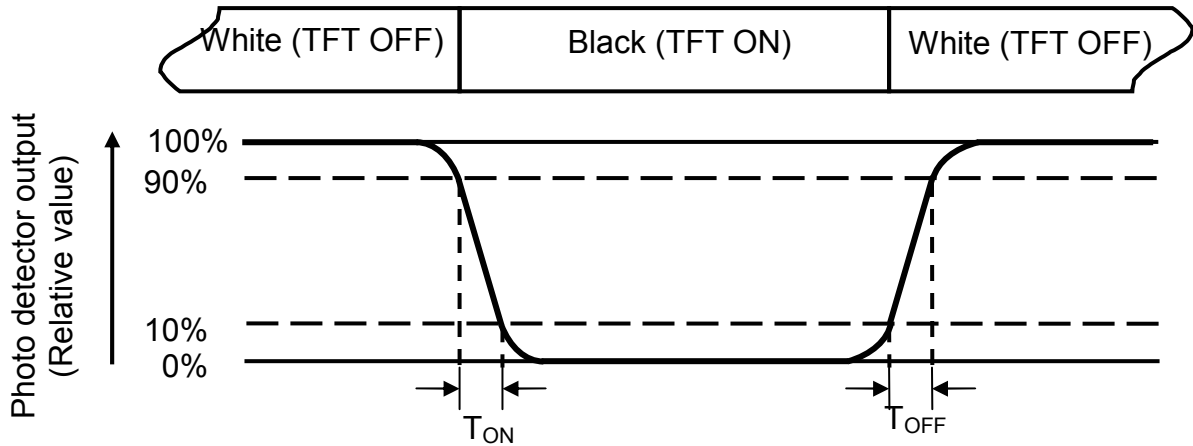

Fig. 4-3 Definition of response time

Note 4: Definition of contrast ratio

$$\text{Contrast ratio (CR)} = \frac{\text{Luminance measured when LCD on the "White" state}}{\text{Luminance measured when LCD on the "Black" state}}$$

Note 5: Definition of color chromaticity (CIE1931)

Color coordinates measured at center point of LCD.

Note 6: All input terminals LCD panel must be ground while measuring the center area of the panel. The LED driving condition is  $I_L=40\text{mA}$ .

Note 7: The values shall be measured without Touch Screen Panel.

Note 8: Definition of Luminance Uniformity

Active area is divided into 9 measuring areas (Refer to Fig. 4-4 ).Every measuring point is placed at the center of each measuring area.

$$\text{Luminance Uniformity (Yu)} = \frac{B_{min}}{B_{max}}$$

L-----Active area length      W----- Active area width

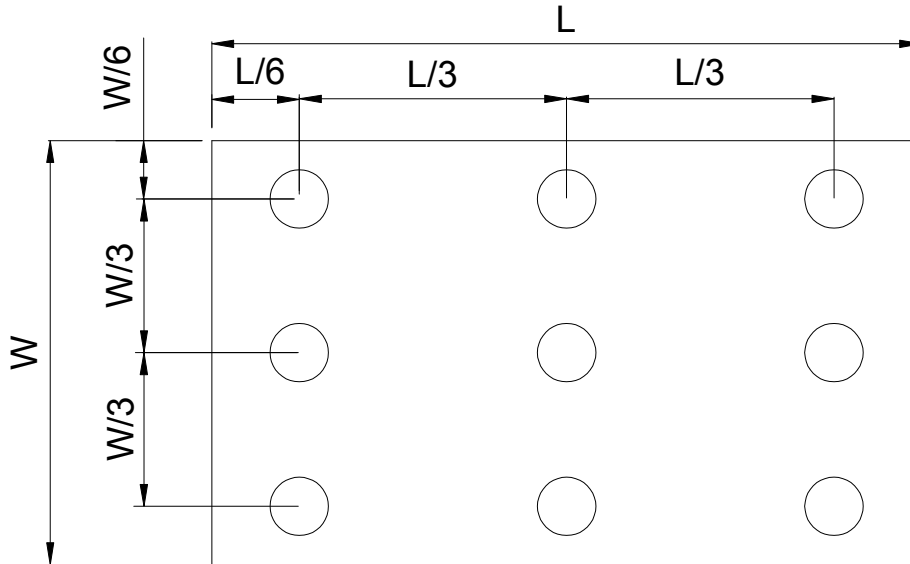

Fig. 4-4 Definition of measuring points

**B<sub>max</sub>**: The measured maximum luminance of all measurement position.

**B<sub>min</sub>**: The measured minimum luminance of all measurement position.

## 6. Reliability Test Items

(Note3)

Item	Test Conditions	Remark
High Temperature Storage	Ta = 70°C                      240 hrs	Note 1,Note 4
Low Temperature Storage	Ta = -20°C                      240hrs	Note 1,Note 4
High Temperature Operation	Ts = 70°C                      240hrs	Note 2,Note 4
Low Temperature Operation	Ta = -20°C                      240hrs	Note 1,Note 4
Operate at High Temperature and Humidity	+60°C, 90%RH                      240 hrs	Note 5
Thermal Shock	-30°C/30 min ~ +80°C/30 min for a total 100 cycles, Start with cold temperature and end with high temperature	Note 4
Vibration Test	Frequency range:10~55Hz Stroke:1.5mm Sweep:10Hz~55Hz~10Hz 2 hours for each direction of X. Y. Z. (6 hours for total)	
Mechanical Shock	100G 6ms,±X, ±Y, ±Z 3 times for each direction	
Package Vibration Test	Random Vibration : 0.015G*G/Hz from 5-200HZ, -6dB/Octave from 200-500HZ 2 hours for each direction of X. Y. Z. (6 hours for total)	
Package Drop Test	Height:60 cm 1 corner, 3 edges, 6 surfaces	
Electro Static Discharge	± 2KV, Human Body Mode, 100pF/1500Ω	

Note 1: Ta is the ambient temperature of samples.

Note 2: Ts is the temperature of panel's surface.

Note 3: In the standard condition, there shall be no practical problem that may affect the display function. After the reliability test, the product only guarantees operation, but doesn't guarantee all the cosmetic specification.

Note 4: Before cosmetic and function tests, the product must have enough recovery time, at least 2 hours at room temperature.

Note 5: Before cosmetic and function tests, the product must have enough recovery time, at least 24 hours at room temperature.



## **7. General Precautions**

### **7.1. Safety**

Liquid crystal is poisonous. Do not put it in your mouth. If liquid crystal touches your skin or clothes, wash it off immediately by using soap and water.

### **7.2. Handling**

1. The LCD panel is plate glass. Do not subject the panel to mechanical shock or to excessive force on its surface.
2. The polarizer attached to the display is easily damaged. Please handle it carefully to avoid scratch or other damages.
3. To avoid contamination on the display surface, do not touch the module surface with bare hands.
4. Keep a space so that the LCD panels do not touch other components.
5. Put cover board such as acrylic board on the surface of LCD panel to protect panel from damages.
6. Transparent electrodes may be disconnected if you use the LCD panel under environmental conditions where the condensation of dew occurs.
7. Do not leave module in direct sunlight to avoid malfunction of the ICs.

### **7.3. Static Electricity**

1. Be sure to ground module before turning on power or operating module.
2. Do not apply voltage which exceeds the absolute maximum rating value.

### **7.4. Storage**

1. Store the module in a dark room where must keep at  $25\pm 10^{\circ}\text{C}$  and 65%RH or less.
2. Do not store the module in surroundings containing organic solvent or corrosive gas.
3. Store the module in an anti-electrostatic container or bag.

### **7.5. Cleaning**

1. Do not wipe the polarizer with dry cloth. It might cause scratch.
2. Only use a soft sloth with IPA to wipe the polarizer, other chemicals might permanent damage to the polarizer.

# 7. Mechanical Drawing

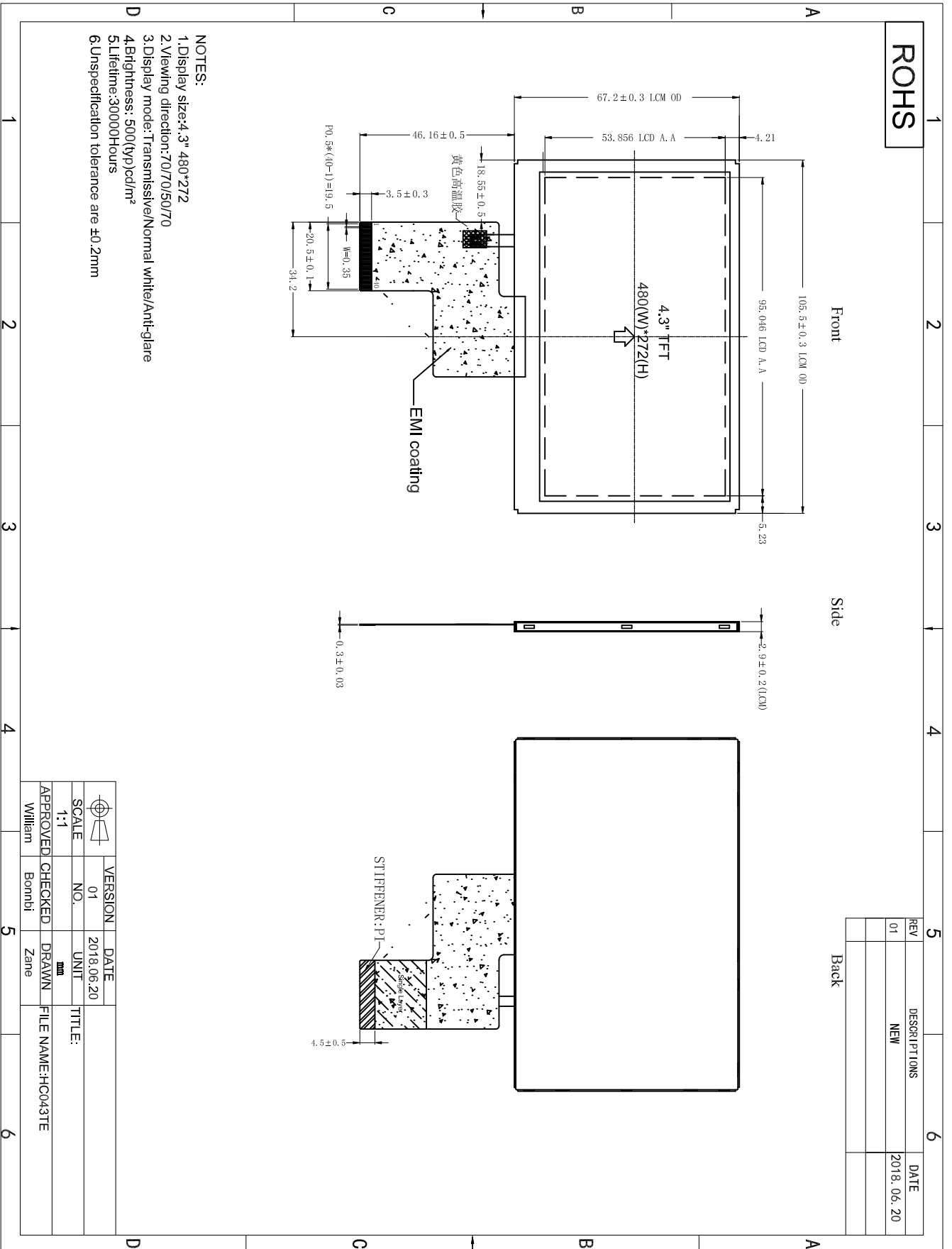

## 9. Package Drawing

### 9.1. Packaging Material Table

No.	Item	Model (Material)	Dimensions (mm)	Unit Weight (kg)	Quantity (pcs)	Remark
1	LCM Module	HC043TE50029-B03V02				

### 9.3. Packaging Drawing

